

Features

- 12" polymer laminate non-pressed paper cone
- Rubber surround
- Vented pole piece
- Extended bump plate
- High temperature aluminum voice coil

Parameters

Impedance (Ω)	8
Re (Ω)	6.4
Le (mH) @ 1 kHz	2.70
Fs (Hz)	26.2
Qms	3.98
Qes	0.48
Qts	0.43
Mms (g)	96.59
Cms (mm/N)	0.38
Sd (cm ²)	498.8
Vd (liters)	214.5
BL (Tm)	14.67
VAS (liters)	133.1
XMAX (mm)	4.3
VC Diameter (mm)	51
SPL (dB@1W/1m)	90.5
RMS Power Handling (w)	80
Usable Frequency Range (Hz)	28 - 2500

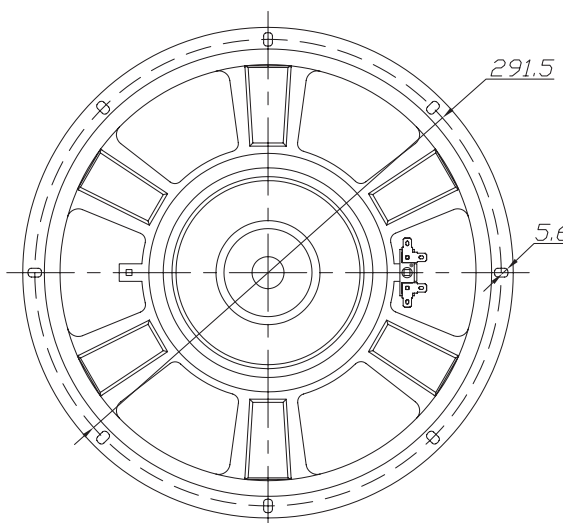
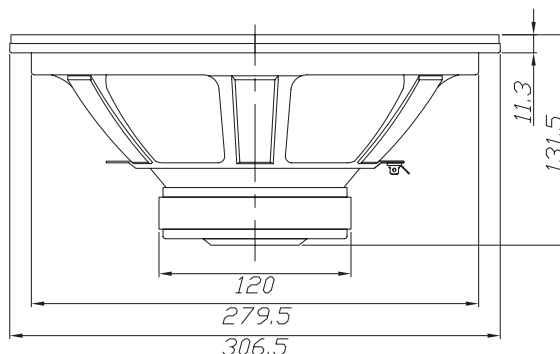

Note: All dimensions in mm.

Frequency Response

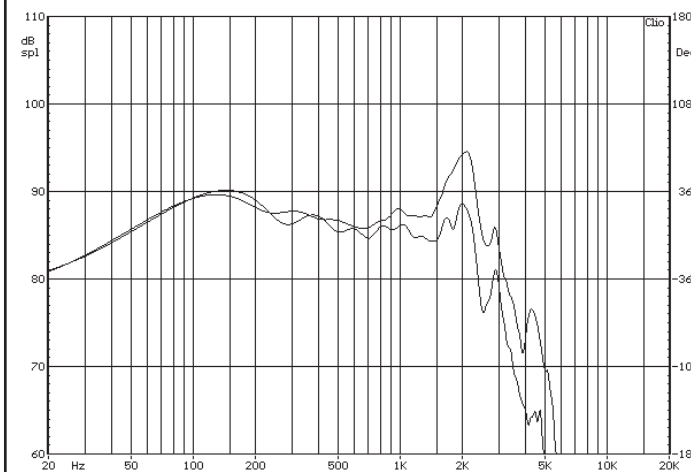

Note: Due to testing limitations, response below 200 Hz is not an actual representation.

Impedance/Phase

