

Features

- Lightweight black anodized aluminum cone
- Attractive 6-hole cast frame
- Advanced low distortion motor design
- Solid aluminum phase plug
- Rubber surround

Parameters

Impedance (Ω)	8
Re (Ω)	6.13
Le (mH) @ 1 kHz	0.59
Fs (Hz)	47.8
Qms	2.15
Qes	0.49
Qts	0.40
Mms (g)	7.5
Cms (mm/N)	1.48
Sd (cm ²)	84.9
Vd (cm ³)	34.0
BL (Tm)	5.3
VAS (liters)	15.0
XMAX (mm)	4.0
VC Diameter (mm)	25.9
SPL (dB@1W/1m)	87.1
RMS Power Handling (w)	40
Usable Frequency Range (Hz)	48 - 4,200

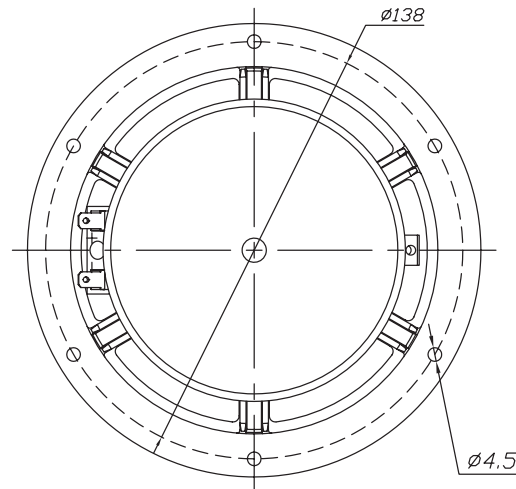
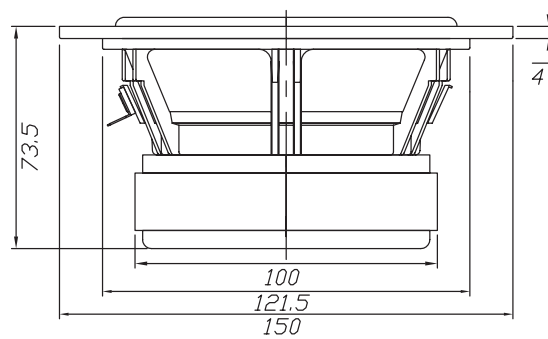

Note: All dimensions in mm.

Frequency Response

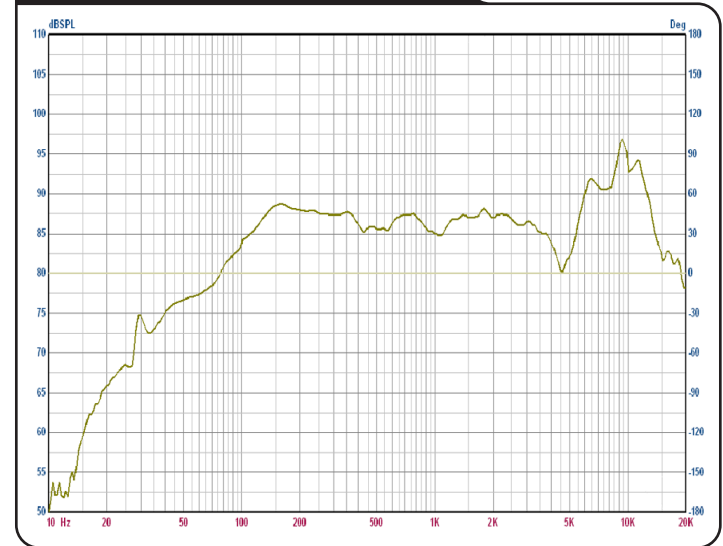

Impedance/Phase

